



thermoscreens®

Designer Range



DESIGNER C RANGE



Features - Designer C Range

- Designed to harmonize with the architectural features of the building
- Manufactured in high grade polished stainless steel
- Advanced turning vane technology
- Suitable for vertical or horizontal applications
- Units available for painting in any RAL colour (Gloss or textured finish)
- Maximum mounting height horizontal unit 2.75m
- Maximum effective width vertical unit 1.5m
- Standard 3 phase (optional down rate to 1 phase)
- Ecopower energy savings control supplied as standard
- Low inertia high efficiency electric heating coil - horizontal unit



thermoscreens®

TECHNICAL SPECIFICATION

** Sound pressure levels (dBA) at 3m, as given in our brochure, are for a single air curtain mounted at its maximum mounting height, operating in a room with average acoustic characteristics as defined in CIBSE Guide B5 (reverberation time 0.7s) and a room size equivalent to 8 air changes per hour (ac/h). Care needs to be taken when selecting air curtains for an installation as noise levels can be several dB higher if the mounting height is reduced, if the room is more "live" (i.e. hard surfaces, no furnishings or absorbent materials), if the room is smaller than 8 ac/h equivalent or a combination of these factors. Noise levels will also increase if more than one air curtain is installed at the same doorway (e.g. + 3dBA for 2 equal point sources: direct field).

Horizontal Designer C Range

Model	Dimensions (mm) (L x D x W)	Supply (50 Hz)	Heat Output (kW)	Loading (A) *per phase	Max. Velocity (m/s)	Max. Air Volume (m³/h)	Weight (kg)	**dB(A) @3m
D1000A	1130 x 362 x 242	230V~1P&N	-	0.7	8.5	1125	30	55
D1500A	1650 x 362 x 242	230V~1P&N	-	0.9	8.5	1620	43	55
D2000A	2130 x 362 x 242	230V~1P&N	-	1.1	8.5	2250	59	56
D2500A	2780 x 362 x 242	230V~1P&N	-	1.6	8.5	2745	73	58
D1000E	1130 x 362 x 242	400V~3P&N	4.5/9	*13.7	8.5	1125	31	55
D1500E	1650 x 362 x 242	400V~3P&N	6/12	*18.3	8.5	1620	44	55
D2000E	2130 x 362 x 242	400V~3P&N	9/18	*27.2	8.5	2250	60	56
D2500E	2780 x 362 x 242	400V~3P&N	10.5/21	*32	8.5	2745	75	58
D1000W	1130 x 362 x 242	230V~1P&N	6	0.7	8	1060	32	55
D1500W	1650 x 362 x 242	230V~1P&N	9	0.9	8	1530	45	55
D2000W	2130 x 362 x 242	230V~1P&N	12	1.1	8	2124	62	56
D2500W	2780 x 362 x 242	230V~1P&N	15	1.6	8	2590	77	58

Vertical Designer C Range

Model	Dimensions (mm) (L x D x W)	Supply (50 Hz)	Heat Output (kW)	Loading (A) *per phase	Max. Velocity (m/s)	Max. Air Volume (m³/h)	Weight (kg)	**dB(A) @3m
D1500A V	1650 x 362 x 242	230V~1P&N	-	0.9	8.5	1620	43	55
D2000A V	2130 x 362 x 242	230V~1P&N	-	1.1	8.5	2250	59	56
D2500A V	2780 x 362 x 242	230V~1P&N	-	1.6	8.5	2745	73	58
D1500E V	1650 x 362 x 242	400V~3P&N	6/12	*18.3	8.5	1620	44	55
D2000E V	2130 x 362 x 242	400V~3P&N	9/18	*27.2	8.5	2250	60	56
D2500E V	2780 x 362 x 242	400V~3P&N	10.5/21	*32	8.5	2745	75	58
D1500W V	1650 x 362 x 242	230V~1P&N	9	0.9	8	1530	45	55
D2000W V	2130 x 362 x 242	230V~1P&N	12	1.1	8	2124	62	56
D2500W V	2780 x 362 x 242	230V~1P&N	15	1.6	8	2590	77	58

Water Flow / Pressure Designer C Range

Air Curtain Model	Water Flow Rate (l/s) 82 / 72°C	Coil Water Pressure Drop (kPa)
D1000W	0.14	2.77
D1500W	0.21	6.74
D2000W	0.29	13.4
D2500W	0.35	15.2



DESIGNER PHV RANGE

Features - Designer PHV Range

- Suitable for vertical or horizontal installations
- Bespoke design
- Manufactured from high grade polished stainless steel
- Units available for painting in any RAL colour (Gloss or textured finish)
- Maximum mounting height horizontal units 3.5m
- Maximum effective width vertical units 2.5m
- Optional quick fit speed controller
- Advanced safety features
- Standard 3 phase (optional down rate to 1 phase)
- Ecopower energy savings control supplied as standard



thermoscreens®

TECHNICAL SPECIFICATION

Horizontal Designer PHV Range

Model	Dimensions (mm) (L x D x W)	Supply (50 Hz)	Heat Output (kW)	Loading (A) *per phase	Max Velocity (m/s)	Max. Air Volume (m ³ /h)	Weight (kg)	**dB(A) @3m
PHV D1000A	1260 x 500 x 350	230V~1P&N	-	1.5	11	2050	54	59
PHV D1500A	1722 x 500 x 350	230V~1P&N	-	2	11	3645	67	60
PHV D2000A	2355 x 500 x 350	230V~1P&N	-	2.9	11	4145	93	61
PHV D1000E	1260 x 500 x 350	400V~3P&N	6/12	*18.7	10.5	1870	57	59
PHV D1500E	1722 x 500 x 350	400V~3P&N	9/18	*27.9	10.5	3325	71	60
PHV D2000E	2355 x 500 x 350	400V~3P&N	12/24	*37.5	10.5	3780	99	61
PHV D1000W	1260 x 500 x 350	230V~1P&N	12	1.3	9.5	1710	61	59
PHV D1500W	1722 x 500 x 350	230V~1P&N	18	1.8	9.5	2730	82	60
PHV D2000W	2355 x 500 x 350	230V~1P&N	24	2.7	9.5	3455	107	61

Vertical Designer PHV Range

Model	Dimensions (mm) (L x D x W)		Supply (50 Hz)	Heat Output (kW)	Loading (A) *per phase	Max Velocity (m/s)	Max. Air Volume (m ³ /h)	Weight (kg)	**dB(A) @3m
PHV D1000A V	1260 x 500 x 350		230V~1P&N	-	1.5	11	2050	54	59
PHV D1500A V	1722 x 500 x 350		230V~1P&N	-	2	11	3645	67	60
PHV D2000A V	2355 x 500 x 350		230V~1P&N	-	2.9	11	4145	93	61
PHV D2500A V (Stacked Unit)	2972 x 500 x 350	Top Air Curtain	230V~1P&N	0.3	1.5	11	2050	121	62
		Bottom Air Curtain	230V~1P&N	0.4	2	11	3645		
PHV D3000A V (Stacked Unit)	3619 x 500 x 350	Top Air Curtain	230V~1P&N	0.3	1.5	11	2050	147	63
		Bottom Air Curtain	230V~1P&N	0.6	2.9	11	4145		
PHV D1000E V	1260 x 500 x 350		400V~3P&N	6/12	*18.7	10.5	1870	57	59
PHV D1500E V	1722 x 500 x 350		400V~3P&N	9/18	*27.9	10.5	3325	71	60
PHV D2000E V	2355 x 500 x 350		400V~3P&N	12/24	*37.5	10.5	3780	99	61
PHV D2500E V (Stacked Unit)	2972 x 500 x 350	Top Air Curtain	400V~3P&N	6/12	*18.7	10.5	1870	146	62
		Bottom Air Curtain	400V~3P&N	9/18	*27.9	10.5	3325		
PHV D3000E V (Stacked Unit)	3619 x 500 x 350	Top Air Curtain	400V~3P&N	6/12	*18.7	10.5	1870	177	63
		Bottom Air Curtain	400V~3P&N	12/24	*37.5	10.5	3780		
PHV D1000W V	1260 x 500 x 350		230V~1P&N	12	1.3	9.5	1710	61	59
PHV D1500W V	1722 x 500 x 350		230V~1P&N	18	1.8	9.5	3040	82	60
PHV D2000W V	2355 x 500 x 350		230V~1P&N	24	2.7	9.5	3455	107	61
PHV D2500W V (Stacked Unit)	2972 x 500 x 350	Top Air Curtain	230V~1P&N	12	1.3	9.5	1710	128	62
		Bottom Air Curtain	230V~1P&N	18	1.8	9.5	3040		
PHV D3000W V (Stacked Unit)	3619 x 500 x 350	Top Air Curtain	230V~1P&N	12	1.3	9.5	1710	156	63
		Bottom Air Curtain	230V~1P&N	24	2.7	9.5	3455		

Water Flow / Pressure Designer PHV Range

Air Curtain Model	Water Flow Rate (l/s) 82 / 72°C	Coil Water Pressure Drop (kPa)
PHV D1000W	0.29	1.14
PHV D1500W, PHV D1500W V	0.43	2.6
PHV D2000W, PHV D2000W V	0.57	4.72
PHV D2500 W V (Stacked Unit)	Top Air Curtain	0.29
	Bottom Air Curtain	0.43
PHV D3000 W V (Stacked Unit)	Top Air Curtain	0.29
	Bottom Air Curtain	0.57

Lower fan speeds with reduced noise can be achieved by using optional quick fit speed controller

DIMENSIONAL DRAWING DESIGNER C RANGE

HORIZONTAL DESIGNER C AIR CURTAIN

Entry Point for Water, Electrical and Control Connections

Bracket for units with length greater than 2.13m

Wall Bracket with 3 off Holes for M8 Rawl Bolts

	D1000H	D1500H	D2000H	D2500H
A(mm)	1130	1650	2130	2780

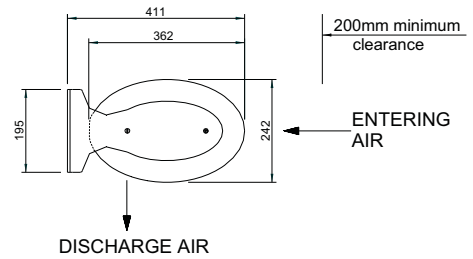
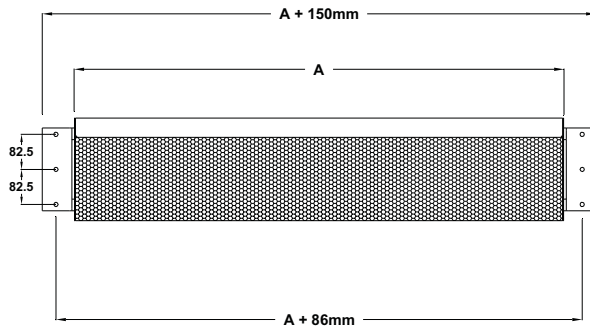

VERTICAL DESIGNER C AIR CURTAIN

200mm minimum clearance

3 Holes for M8
Distance between hole centres 82.5mm

	D1500V	D2000V	D2500V
A(mm)	1650	2130	2780

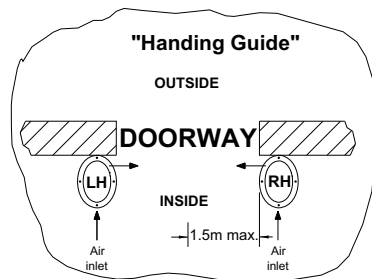
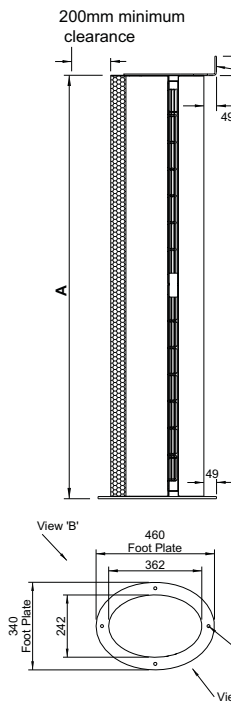

View 'A'

View 'B'

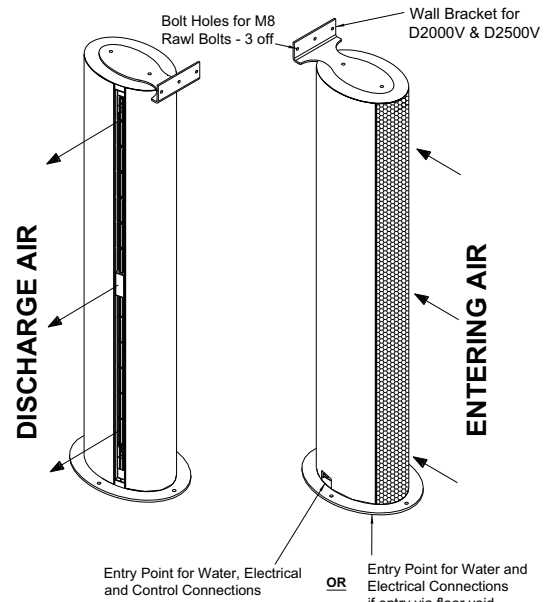

**As Drawn for L.H.
Opposite Hand for R.H.**



DIMENSIONAL DRAWING DESIGNER PHV RANGE

HORIZONTAL DESIGNER PHV AIR CURTAIN

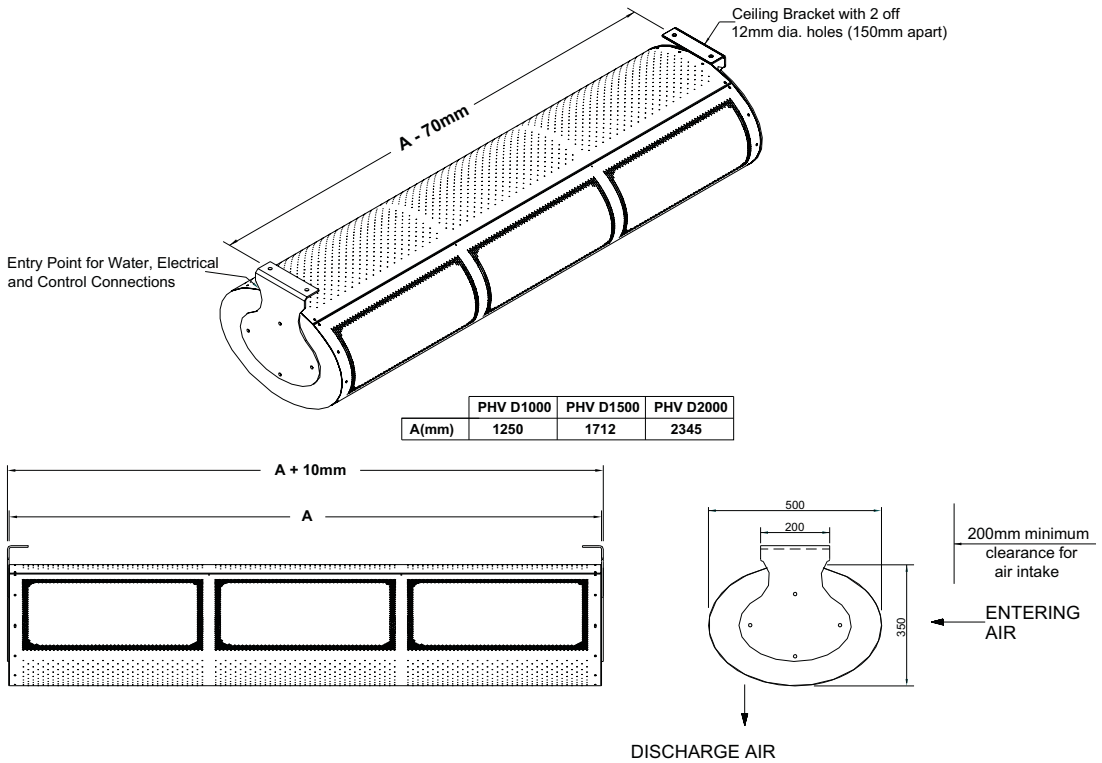

VERTICAL DESIGNER PHV AIR CURTAIN

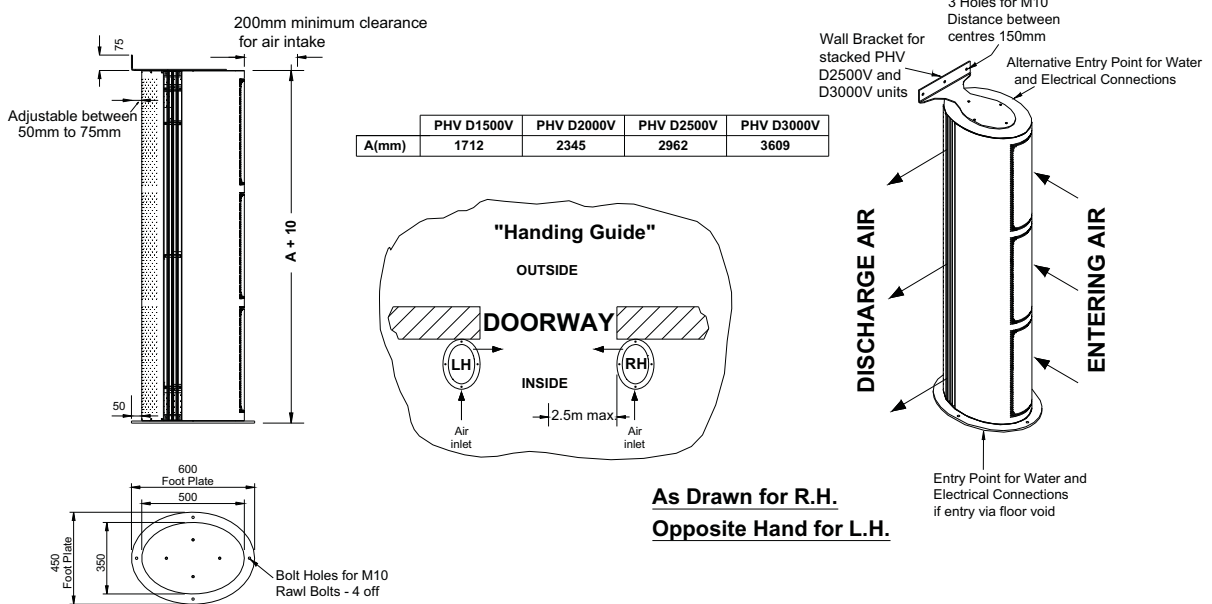

COIL PRESSURE DROPS

Water Coil Pressure Drop Designer C Range

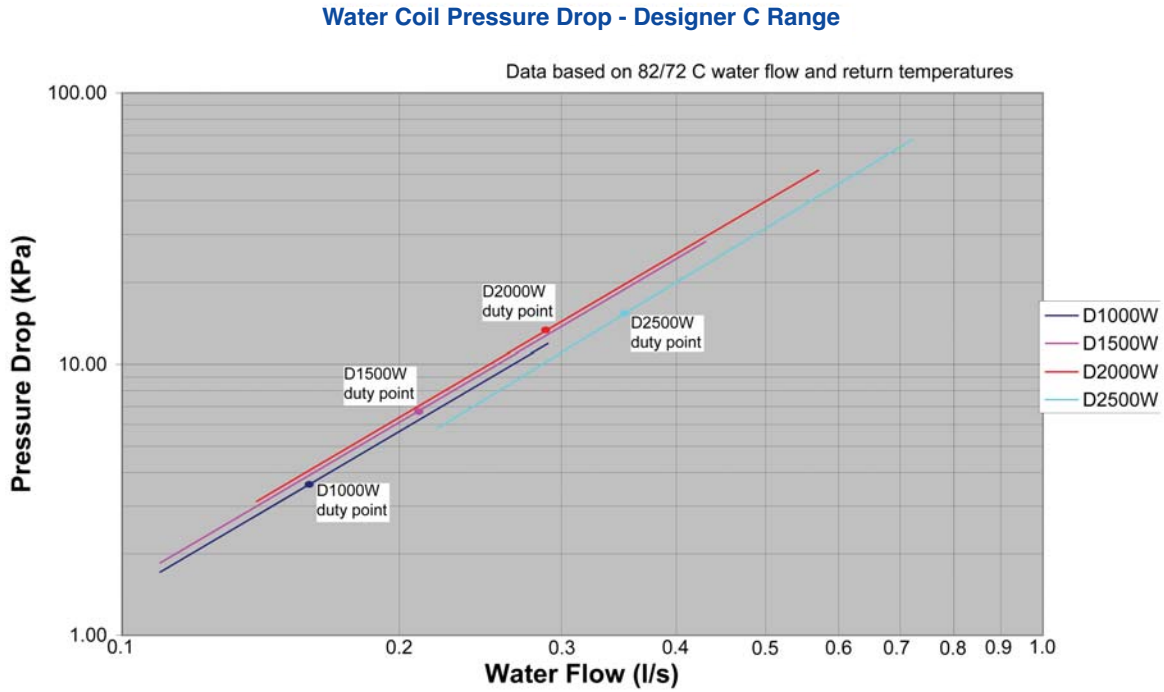

Water Coil Pressure Drop Designer PHV Range

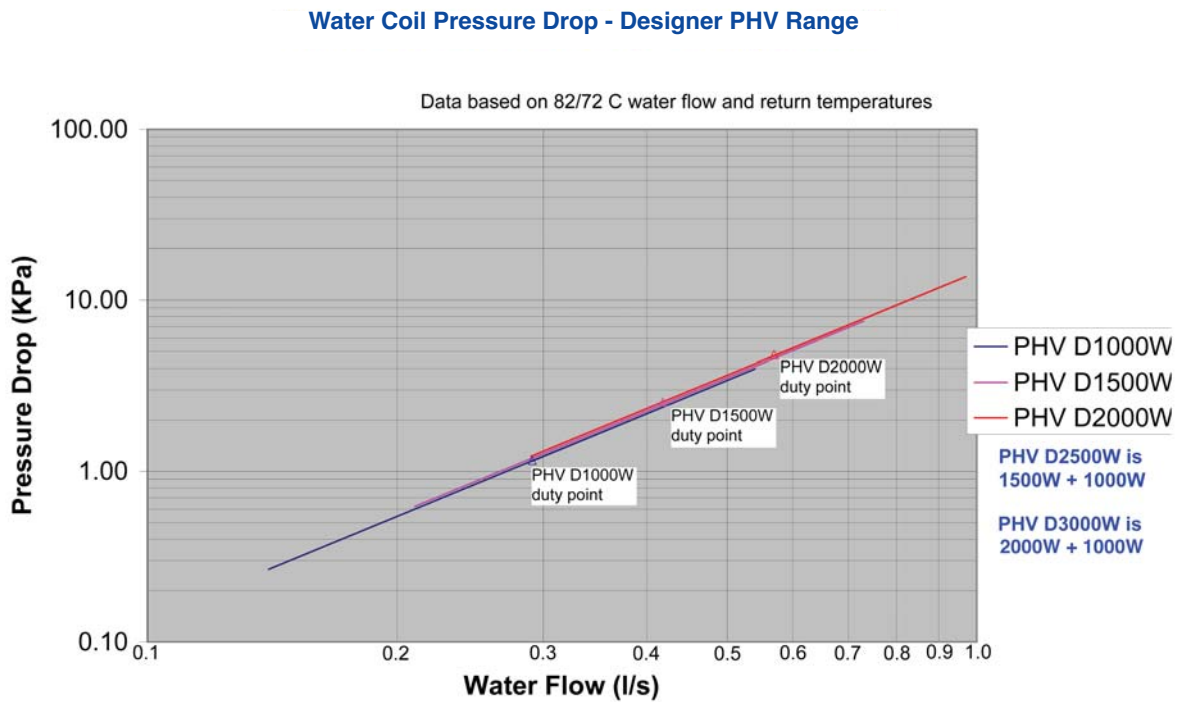

MULTIPLE INSTALLATIONS

Horizontal

To Master/Slave two or more air curtains together, or if there are two air curtains in a vertical stack, the remote control is plugged into the first unit (the Master) and a RJ extension lead then connected from the Master to the Slave unit(s).

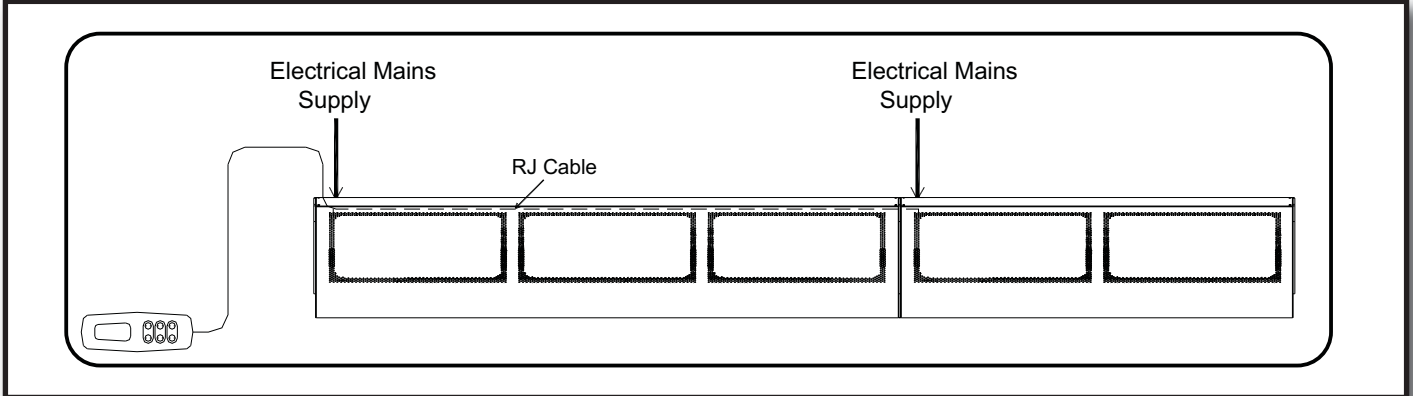

Vertical

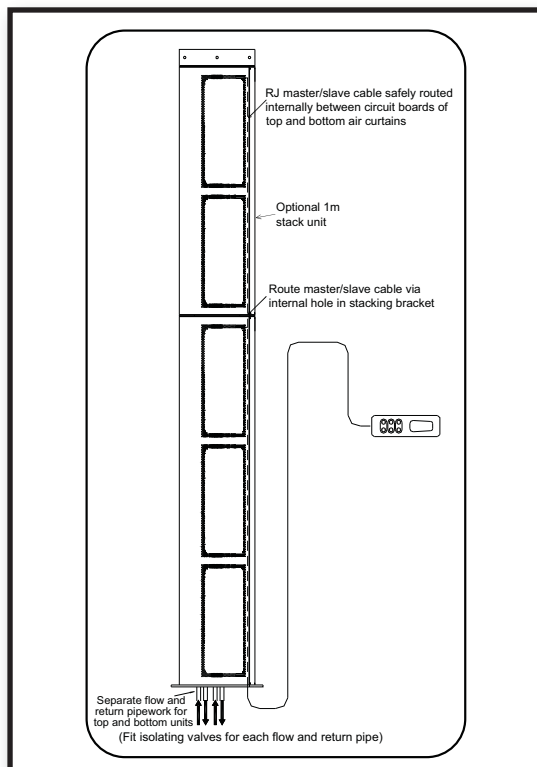

ACCESSORIES

Remote Controller



Motorised Valve (LPHW units only)



Spare casing socket

2.5mm hexagon key wrench

M10 stainless steel dome nuts (vertical unit)

M8 stainless steel dome nuts (horizontal unit)

Fixing kits (if applicable)

RJ extension lead (vertical unit)

THE PERFECT ENVIRONMENT



Thermoscreens' Ecopower Controller is designed to prevent entrance areas over heating whilst also providing all-important and measurable energy savings.

The easy-to-use controller can be set in 'auto mode' to ensure consistent comfort levels are thermostatically maintained. Alternatively, the Ecopower Controller can be manually set for constant 50% or 100% heat output or zero heat output to provide a barrier of ambient air during warmer weather to assist the air conditioning within the environment.

The Benefits

The Ecopower Controller maintains consistent temperature levels within the internal environment.

■ Saves Energy:

The Ecopower Controller ensures the air curtain operates at the optimum heat output, ensuring a controlled climate and thus saving energy and money.

■ Ideal for Multiple Installation:

The Ecopower Controller allows the control of fan speeds, heat output and temperature settings in multiple installations of up to 8 separate air curtains.

■ Easy to Install:

The Ecopower Controller is quick and easy to install as it incorporates low voltage switch cabling, eliminating the need for mains rated conduit runs. In addition, the quick-fit plug-in connectors allow multiple units to be simply linked together using the optional RJ lead.

CONTROL OPTIONS

- BMS On/Off
- BMS Fault Signal
- Fan/Heat Interlock
- Master/Slave single temperature sensor
- Remote Heating On/Off
- Outside Air temperature sensing control



ADVANCED TECHNOLOGY

The Thermoscreens Designer Vertical Range of air curtains incorporate crossflow fan technology. This enables our range of air curtains to produce a more uniform air velocity and air flow across the length of the discharge grille. The Designer Vertical Range has been conceptualized to optimize 'draw through', giving a better air flow over the heater battery and additional space for bigger heating coils.

Turning vanes have been fitted at each end of the crossflow impellers and at the middle of the air curtain for 2m units. The location of the fan motors and electrical equipment can sometimes produce low velocity zones; the turning vanes system effectively 'fills-in' these low velocity areas. The effectiveness of these vanes has been proven through a series of 'outlet velocity projection and uniformity' tests in accordance with the ISO standard 27327-1 (formerly ANSI/AMCA Standard 220-05 for air Curtain Performance Rating).

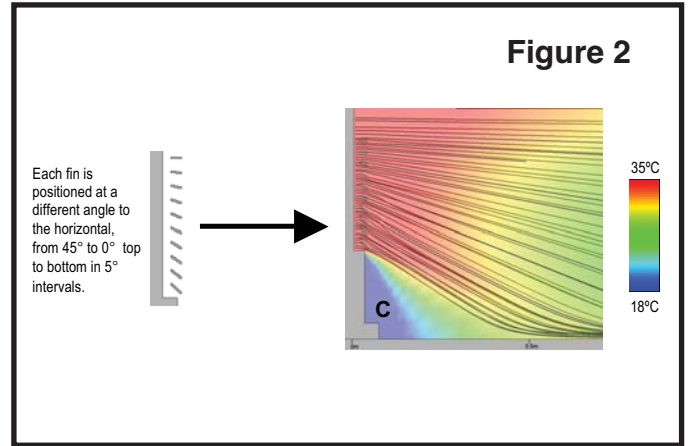
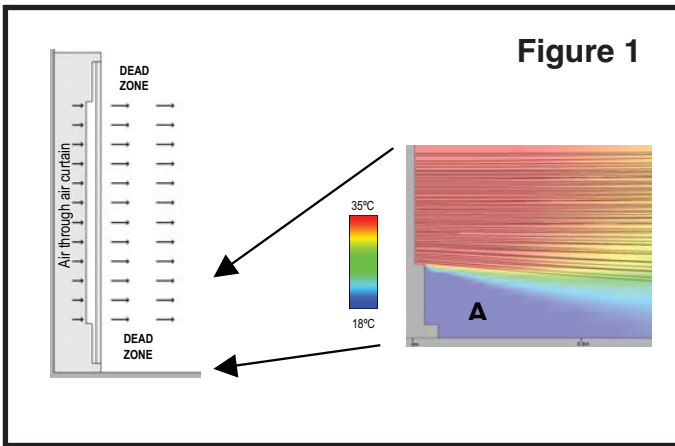
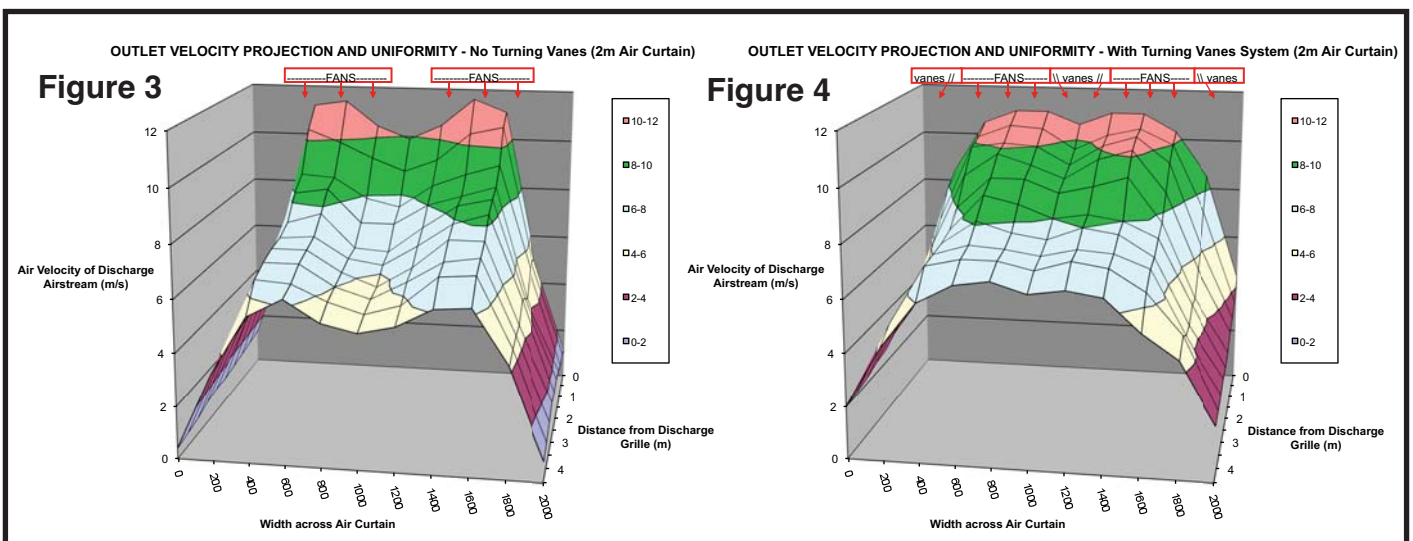

Figure 1 shows a Computational Fluid Dynamics (CFD) analysis carried out on a Designer Vertical air curtain which is not fitted with a turning vane system. The reduced air flow zones where the motors and electrical controls are located are indicated at the top and bottom of the air curtain (Marked A).

Figure 2 is a CFD analysis of a Vertical Designer unit fitted with the advanced turning vane system. The angle of the turning vanes increases from 0 to 45 degrees towards the end of the air curtain giving a gradual effect, filling in the low air velocity areas in a more even manner.



The 3D surface charts show this for a 2m Designer PHV air curtain where the low velocity areas shown at the ends and the middle in figure 3 are "filled-in" by the turning vane system as shown in figure 4.



thermoscreens®



WORLDWIDE DISTRIBUTORS

Australia Austria Bahrain Belgium Brazil Bulgaria Canada Chile Cyprus Denmark Estonia Finland France Germany Hungary Iceland Italy Kazakhstan
Kuwait Latvia Lithuania Malta Oman Poland Portugal Qatar Rep.of Ireland Romania Russia Slovenia Spain
The Netherlands Turkey UAE UK

All Thermoscreens products are certified in accordance with CE regulations
and where applicable comply with the following standards:

EN 60335-2-30, 89/336/EEC Electromagnetic Compatibility (EMC),

Machinery Directive (89/392/EEC, as amended by 91/368/EEC, 93/44/EEC and 93/68/EEC)

Low Voltage Directive, (72/23/EEC as amended by 93/68/EEC)

IP21 Rating CSA - Standard 22.2 UL 2021 / UL 1995, GOST R 23511-79, GOST R 50033-92



thermoscreens®

Thermoscreens Limited, St. Mary's Road, Nuneaton, Warwickshire CV11 5AU

Telephone: +44 (0) 2476 384 646 Fax: +44 (0) 2476 388 578 E-mail: sales@thermoscreens.com Web site: www.thermoscreens.com

All information within this brochure is for reference purposes only.

Products are manufactured under a continuous improvement process and details may change.

Issue 2

A CARVER GROUP COMPANY

Registered in England no. 691333